

по вопросам продаж и поддержки обращайтесь:

Архангельск (8182)63-90-72 Астана +7(7172)727-132 Белгород (4722)40-23-64 Брянск (4832)59-03-52
Владивосток (423)249-28-31 Волгоград (844)278-03-48 Вологда (8172)26-41-59 Воронеж (473)204-51-73
Екатеринбург (343)384-55-89 Иваново (4932)77-34-06 Ижевск (3412)26-03-58 Казань (843)206-01-48
Калининград (4012)72-03-81 Калуга (4842)92-23-67 Кемерово (3842)65-04-62 Киров (8332)68-02-04
Краснодар (861)203-40-90 Красноярск (391)204-63-61 Курск (4712)77-13-04 Липецк (4742)52-20-81
Магнитогорск (3519)55-03-13 Москва (495)268-04-70 Мурманск (8152)59-64-93 Набережные Челны (8552)20-53-41
Нижний Новгород (831)429-08-12 Новокузнецк (3843)20-46-81 Новосибирск (383)227-86-73 Орел (4862)44-53-42
Оренбург (3532)37-68-04 Пенза (8412)22-31-16 Пермь (342)205-81-47 Ростов-на-Дону (863)308-18-15
Рязань (4912)46-61-64 Самара (846)206-03-16 Санкт-Петербург (812)309-46-40 Саратов (845)249-38-78
Смоленск (4812)29-41-54 Сочи (862)225-72-31 Ставрополь (8652)20-65-13 Тверь (4822)63-31-35
Томск (3822)98-41-53 Тула (4872)74-02-29 Тюмень (3452)66-21-18 Ульяновск (8422)24-23-59
Уфа (347)229-48-12 Челябинск (351)202-03-61 Череповец (8202)49-02-64 Ярославль (4852)69-52-93

единый адрес: dbk@nt-rt.ru

Rugged Tablet PC

User's Manual



Table of Contents

COPYRIGHT	4
REGULATORY STATEMENT	4
<i>Federal Communications Commission Statement</i>	4
<i>Caution</i>	4
<i>Declaration of Conformity</i>	4
<i>RF exposure warning</i>	5
<i>Canada, Industry Canada (IC) Notices</i>	5
<i>Battery Disposal</i>	6
<i>CLASS 1 LASER PRODUCT</i>	6
<i>FCC Warning</i>	7
<i>IC Warning</i>	7
BEFORE YOU START	8
PACKAGE CONTENTS	8
COMPONENTS	9
<i>Front View</i>	9
<i>Back View</i>	11
<i>Right View</i>	12
<i>Left View</i>	12
<i>Top View</i>	13
<i>Bottom View</i>	13
<i>Status Indicators</i>	14
GETTING STARTED	15
POWERING UP YOUR TABLET PC	15
<i>Using Battery Power</i>	15
INSTALLING THE BATTERIES	15
<i>Charging the Battery</i>	16
<i>Charging Time</i>	16
<i>Checking the Battery Level</i>	17
<i>When to replace the Battery Pack</i>	18
<i>Removing the Batteries</i>	18
STARTING YOUR TABLET PC	19
<i>Turning On Your Tablet PC</i>	19
<i>Changing the Display Orientation</i>	19
USING THE STYLUS	20
<i>Calibrate the Screen</i>	20
USING THE QUICK MENU	21

USING THE BIOS SETUP UTILITY	24
BIOS SETUP MENU	24
STARTING THE BIOS SETUP UTILITY	24
NAVIGATING AND ENTERING INFORMATION IN BIOS.....	25
OPTIONAL DEVICES	26
MAGNETIC STRIPE READER (MSR)	26
<i>MSR Specification</i>	26
SPECIFICATIONS	27

Copyright

Copyright© 2012. All rights reserved.

No part of this user manual may be transmitted, stored in a retrieval system, or translated into any language or computer language, in any form or by any means, without the prior written permission of the manufacturer. Information is subject to change without prior notice.

Regulatory Statement

Federal Communications Commission Statement

This equipment has been tested and found to comply with the limits for a Class B digital device, pursuant to Part 15 of the FCC Rules. These limits are designed to provide reasonable protection against harmful interference in a residential installation. This equipment generates, uses, and can radiate radio frequency energy and, if not installed and used in accordance with the instructions, may cause harmful interference to radio communications. However, there is no guarantee that interference will not occur in a particular installation. If this equipment does cause harmful interference to radio or television reception, which can be determined by turning the equipment off and on, the user is encouraged to try to correct the interference by one or more of the following measures:

- Reorient or relocate the receiving antenna.
- Increase the separation between the equipment and the receiver.
- Connect the equipment into an outlet on a circuit different from that to which the receiver is connected.
- Consult the dealer or an experienced radio/TV technician for help.

Shielded interconnect cables and shielded AC power cable must be employed with this equipment to insure compliance with the pertinent RF emission limits governing this device. Changes or modifications not expressly approved by the system's manufacturer could void the user's authority to operate the equipment.

Caution

Any changes or modifications not expressly approved by the grantee of this device could void the user's authority to operate the equipment.

Declaration of Conformity

This device complies with part 15 of the FCC rules. Operation is subject to the following conditions:

- This device may not cause harmful interference
- This device must accept any interference received, including interference that may cause undesired operation.

RF exposure warning

This equipment must be installed and operated in accordance with provided instructions and must not be co-located or operating in conjunction with any other antenna or transmitter. End-users and installers must be provided with antenna installation instructions and transmitter operating conditions for satisfying RF exposure compliance.

SAR Value: 1.119 W/kg

Canada, Industry Canada (IC) Notices

This Class B digital apparatus complies with Canadian ICES-003 and RSS-210. Operation is subject to the following two conditions: (1) this device may not cause interference, and (2) this device must accept any interference, including interference that may cause undesired operation of the device.

Radio Frequency (RF) Exposure Information

The radiated output power of the Wireless Device is below the Industry Canada (IC) radio frequency exposure limits. The Wireless Device should be used in such a manner such that the potential for human contact during normal operation is minimized.

This device has been evaluated for and shown compliant with the IC Specific Absorption Rate ("SAR") limits when installed in specific host products operated in portable exposure conditions.

Canada, avis d'Industry Canada (IC)

Cet appareil numérique de classe B est conforme aux normes canadiennes ICES-003 et RSS-210.

Son fonctionnement est soumis aux deux conditions suivantes : (1) cet appareil ne doit pas causer d'interférence et (2) cet appareil doit accepter toute interférence, notamment les interférences qui peuvent affecter son fonctionnement.

Informations concernant l'exposition aux fréquences radio (RF)

La puissance de sortie émise par l'appareil de sans fil est inférieure à la limite d'exposition aux fréquences radio d'Industry Canada (IC). Utilisez l'appareil de sans fil de façon à minimiser les contacts humains lors du fonctionnement normal.

Ce périphérique a été évalué et démontré conforme aux limites SAR (Specific Absorption Rate – Taux d'absorption spécifique) d'IC lorsqu'il est installé dans des produits hôtes particuliers qui fonctionnent dans des conditions d'exposition à des appareils portables.

Battery Disposal

THIS PRODUCT CONTAINS A LITHIUM-ION OR NICKEL-METAL HYDRIDE BATTERY. IT MUST BE DISPOSED OF PROPERLY. CONTACT LOCAL ENVIRONMENTAL AGENCIES FOR INFORMATION ON RECYCLING AND DISPOSAL PLANS IN YOUR AREA.

CLASS 1 LASER PRODUCT

LASERSCHUTZKLASSE 1 PRODUKT TO EN60825

CAUTION: THIS APPLIANCE CONTAINS A LASER SYSTEM AND IS CLASSIFIED AS A "CLASS 1 LASER PRODUCT." TO USE THIS MODEL PROPERLY, READ THE INSTRUCTION MANUAL CAREFULLY AND KEEP THIS MANUAL FOR FUTURE REFERENCE. IN CASE OF ANY TROUBLE WITH THIS MODEL, PLEASE CONTACT YOUR NEAREST "AUTHORIZED SERVICE STATION." TO PREVENT DIRECT EXPOSURE TO THE LASER BEAM, DO NOT TRY TO OPEN THIS ENCLOSURE.

ANNEX IV

Symbol for the marking of electrical and electronic equipment

The symbol indicating separate collection for electrical and electronic equipment consists of the crossed-out wheeled bin, as shown below. The symbol must be printed visibly, legibly and indelibly.



CAUTION FOR ADAPTER

THIS TABLET PC IS FOR USE WITH DEDICATED AC ADAPTER.

BATTERY SAFETY

DANGER OF EXPLOSION IF BATTERY IS INCORRECTLY REPLACED.

REPLACE ONLY WITH THE SAME OR EQUIVALENT TYPE RECOMMENDED BY THE MANUFACTURER. DISPOSE OF USED BATTERIES ACCORDING TO THE MANUFACTURER'S INSTRUCTIONS.

CAUTION FOR RJ-45

The RJ-45 jack is not used for telephone line connection.

FCC Warning

This device complies with part 15 of the FCC Rules. Operation is subject to the following two conditions:

1. This device may not cause harmful interference, and
2. this device must accept any interference received, including interference that may cause undesired operation.

IC Warning

This Class B digital apparatus complies with Canadian ICES-003.

Cet appareil numérique de la classe B est conforme à la norme NMB-003 du Canada.

Before You Start

Congratulations on your purchase of this tablet PC.

This rugged tablet PC is portable and provides users with maximum mobile computing experience in a wide range of working environments. Before you begin using your tablet PC, read this chapter to familiarize yourself with the main components installed in the system.

Package Contents

If any of following item is damaged, please contact your retailer.



Tablet PC



Power cord



Power adapter



Stylus Pen



Hand-strap





NOTE

- The pictures are for reference only, actual items may slightly differ.



Components

Front View



No.	Item	Description
1	Light Sensor	Sense the ambient light condition for auto backlight setting function.
2	Webcam	Use for video conference.
3	Microphone	Receive audio input.
4	Speaker	Emit sound.
5	Status Indicators (Power, Battery, Wireless)	Indicate the corresponding function status. See "Status Indicators" on page 14.
6	Quick Menu button	 Press to launch the Quick Menu.
7	Lock button	 Press to launch the log in menu, similar as pressing <Ctrl> + <Alt> + on a PC.

Before You Start

No.	Item		Description
8	Function button (P2)	P2	Press to launch an application assigned to the button. See "Setup on page 22" to program the function button.
9	Function (P1) / Rotate button	P1 	By default, press this button to rotate the display 90° clockwise. Or, press this button to launch an assigned application. See "Setup on page 22" to program the function button.
10	Power button		Press to power on and off the tablet PC.

Back View

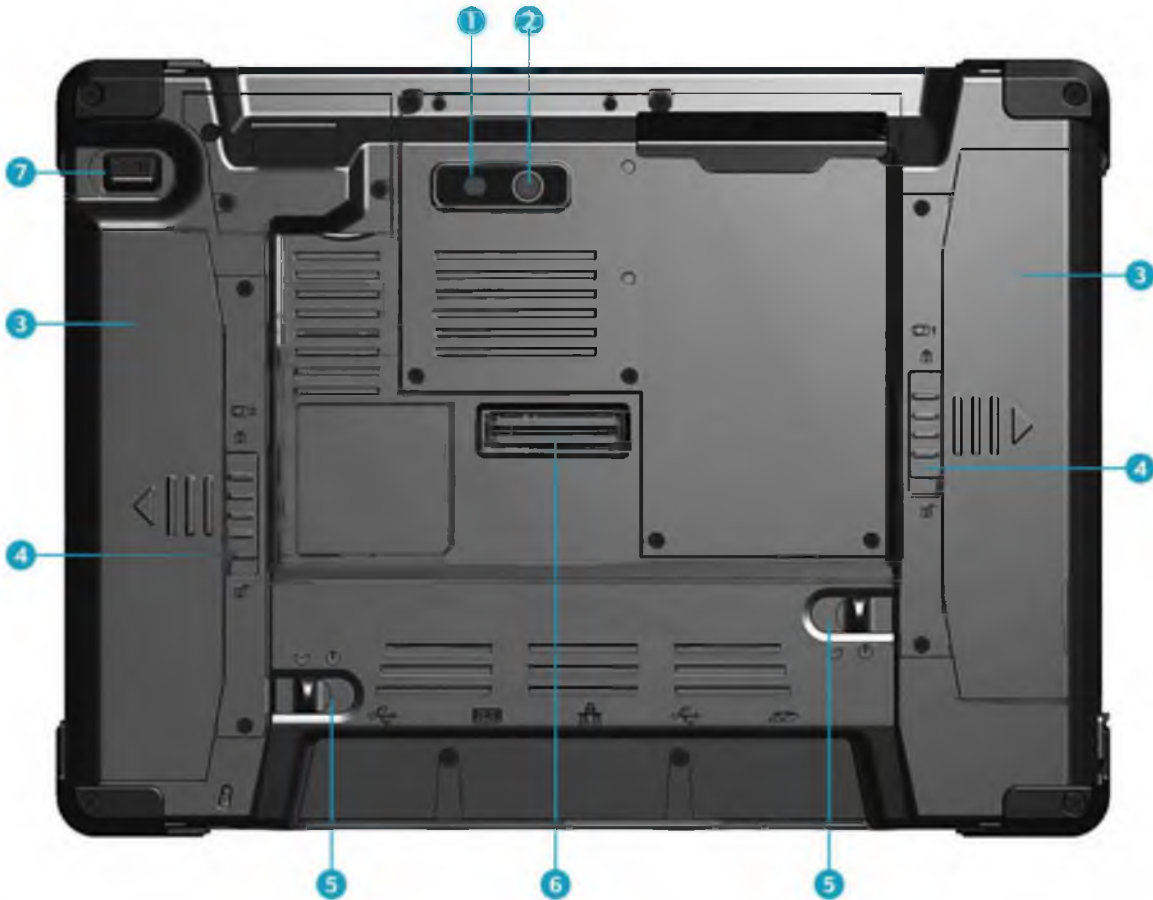

No.	Item	Description
1	Camera LED flash	Provide additional lighting when taking pictures under low light environment.
2	Camera	Use to take pictures.
3	Battery pack	Supply battery power to your tablet PC.
4	Battery latch	Slide down the latch to release the battery pack from the compartment.
5	Battery lock	Lock the battery latch.
6	Docking connector	Connect the tablet PC to a docking station.
7	Scanner button	Press to trigger the Barcode scan function if the barcode scanner is on. It can also be assigned as the camera button in Quick Menu.

Right View



Left View

With battery pack



Without battery pack



No.	Item	Description
1	DC-in jack	Connect the power adapter.
2	SIM card slot	Use to insert a SIM card for WWAN, Gobi 3000, or LTE module connection.

Top View



No.	Item	Description
1	Barcode scanner	Use to scan for barcodes.
2	Smart card reader	Use to insert smart cards.

Bottom View







No.	Item	Description
1	SD card slot	Use to insert an SD card for external storage.
2	USB port	Connect USB peripheral devices.
3	LAN (RJ-45) port	Connect to a local area network (LAN) using an Ethernet cable.
4	Serial port (RS-232)	Connect a peripheral device, such as a printer or other device with serial port.
5	Kensington lock slot	Connect to a Kensington-compatible tablet PC security lock.

Status Indicators

The status indicators in the lower right corner of the tablet PC light up when a particular function of the tablet PC is active. Each indicator is marked with a symbol.



Icon	Item	Description
	Power	Indicate the power status: <ul style="list-style-type: none">• Off: Power is off or the tablet PC is in hibernate mode.• Green: Power is on.• Blinking Green: The tablet PC is in standby or sleep mode.
 	Battery	Indicate the status of battery 1 and battery 2: <ul style="list-style-type: none">• Green: The battery is fully charged with 95% power or above.• Orange: The battery is charging.• Flashing Orange: Charging error.• Red: The battery is low with less than 10% power.• Off: The battery is discharged.
	RF	The RF LED lights blue when the wireless (WLAN) and/or Bluetooth function is enabled.

Getting Started

This chapter will guide you on how to use your tablet PC.

Powering Up Your Tablet PC

Your tablet PC can be powered up using the AC adapter or the Lithium-ion battery.

Using Battery Power

1. Install a charged battery in the battery compartment.
2. Remove the AC adapter (if plugged). Your tablet PC will automatically use the battery power.



NOTE

- If your tablet PC is connected to an electrical outlet and the battery is installed, your tablet PC uses power from the electrical outlet.

Installing the Batteries

To install the batteries, follow the steps below:

1. Make sure the battery lock is in the unlock  position.
2. Slide the battery pack into the compartment and push completely until the battery locks into place.



Getting Started

- Slide the battery lock to the lock  position.



- Repeat steps 1 to 3 to insert the second battery.



Charging the Battery

The Lithium-ion battery is not fully-charged upon purchase.

To charge the battery, follow the steps below:

- Install the battery to your tablet PC.
- Connect the AC adapter to the DC-in jack of your tablet PC.
- Connect the AC adapter to the power cord.
- Plug the power cord to an electrical outlet.

Charging Time

Number of battery pack	Charging duration (at 25°C)
1	3.5 hours
2	6.5 hours



NOTE

- The charging time may be longer if you are using your tablet PC while charging the battery.

CAUTION

- DO NOT charge the battery if the temperature is below 0°C or higher than 60°C.
- Use only the supplied AC adapter. Using other AC adapters may damage the battery or your tablet PC.

Checking the Battery Level

It is important that you monitor the battery status regularly to ensure you do not run out of power at a critical moment.

To check the remaining battery power, double tap the battery icon in the system tray. The battery screen appears:

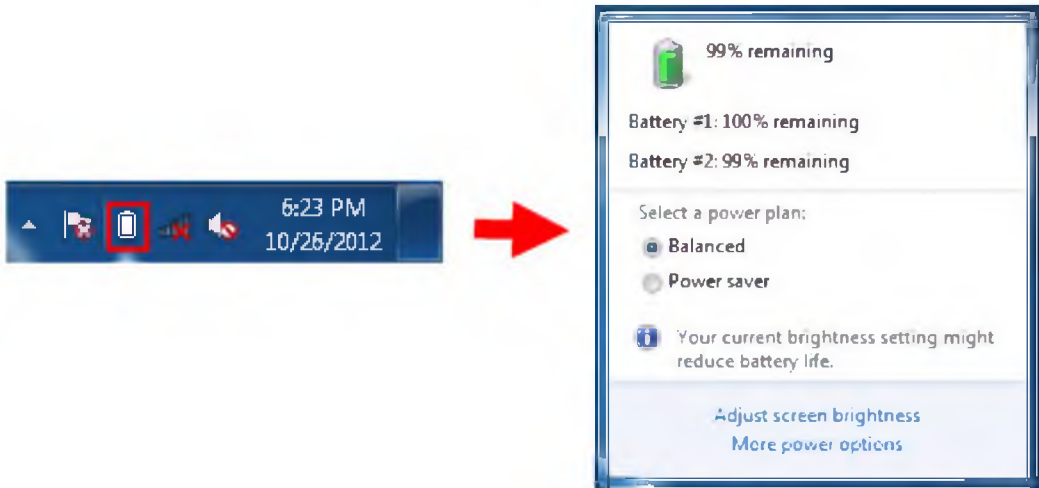

When to replace the Battery Pack

The battery performance gradually decreases over time and usage. We recommend you to replace your battery pack after 18 to 24 months of usage.

Removing the Batteries

To remove the batteries, follow the steps below:

1. Slide the battery lock to the unlock  position.



2. Press and hold down the battery latch and slide the battery to remove it from the compartment.



3. Repeat steps 1 and 2 to remove another battery.



Starting Your Tablet PC

Turning On Your Tablet PC

Press the  button until the Power LED lights up.

Changing the Display Orientation

You can rotate the display orientation to suit your preference. Press the **P1** button to rotate the display 90°, 180°, and 270° clockwise.



NOTE

- You need to disable the *Auto Rotate* option in the Quick menu before pressing the shortcut button (**P1**) to rotate the display.
- Repeatedly press **P1** to rotate the display 180° and 270° clockwise.

Using the Stylus

This tablet PC may come with an integrated stylus for accurate control input to the LCD touch panel. You can use the stylus to point, select, or drag items or objects on the screen.

Calibrate the Screen

To ensure touch accuracy, calibrate the screen.

1. Tap **Start** > **Control Panel**.
2. Select **Hardware and Sound** > **Tablet PC Settings**.

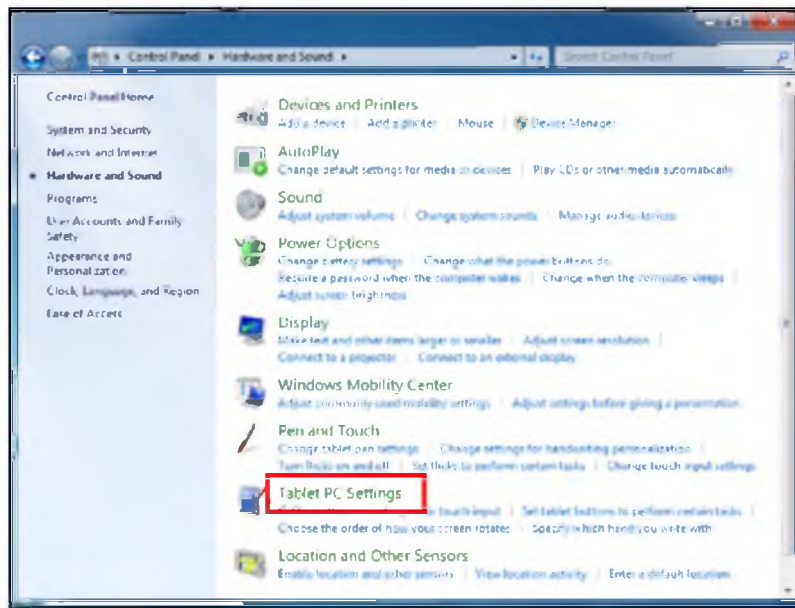

3. Tap **Calibrate**.
4. Follow the on-screen instructions to complete screen calibration.

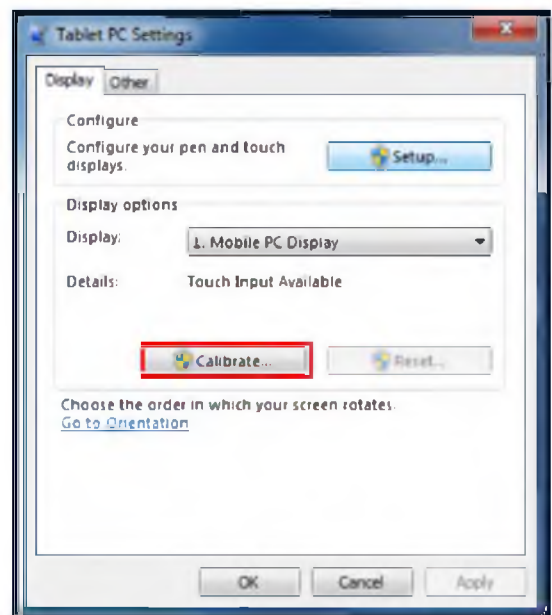





NOTE:

- If the optional digitizer is enabled, use a pencil to do the touch panel calibration instead of using the digitizer pen.

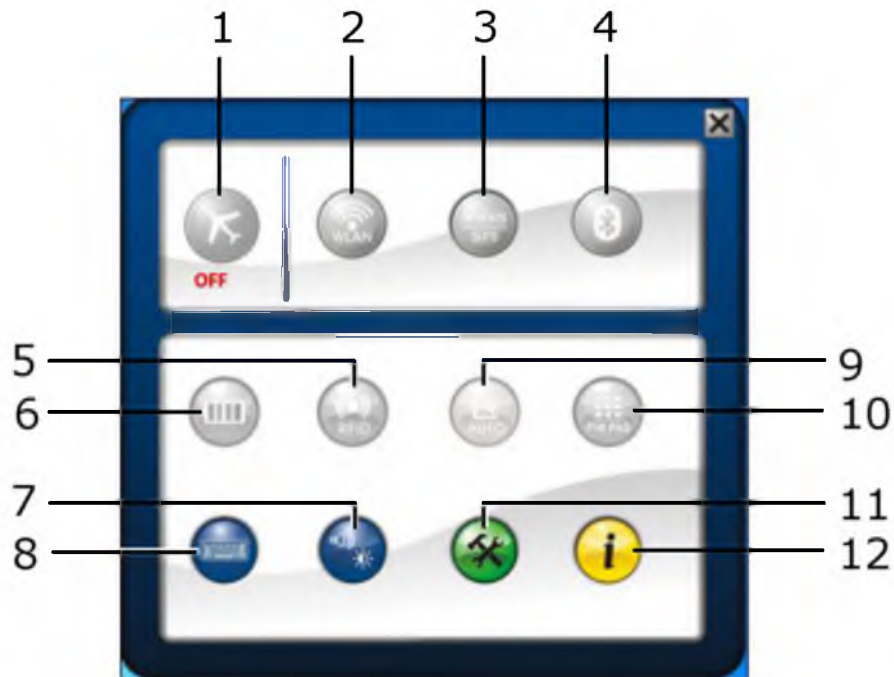

Using the Quick Menu

Press the **Quick Menu**  button to enter the Quick menu.



No.	Item	Description
1	Airplane mode	Tap the icon to enable/disable airplane mode.  NOTE: <ul style="list-style-type: none"> When the Airplane mode is enabled, the wireless network (WLAN and WWAN), Bluetooth, and GPS will be automatically disabled.
2	WLAN	Tap the icon to enable/disable the Wi-Fi (WLAN) function.
3	WWAN	Tap the icon to enable/disable the WWAN/GPS function.  NOTE: <ul style="list-style-type: none"> Optional function; availability depends on the tablet PC specifications.
4	Bluetooth	Tap the icon to enable/disable the Bluetooth function.
5	RFID	Tap the icon to enable the RFID function.  NOTE: <ul style="list-style-type: none"> Optional function; availability depends on the tablet PC

Getting Started

No.	Item	Description
		specifications.
6	Barcode	Tap the icon to enable the Barcode Scanner function.
7	Mobility center	Tap the icon to adjust brightness, screen orientation, volume, external display, battery status, sync, wireless network, and presentation settings. 
8	Keyboard	Tap the icon to display the on-screen keyboard.
9	Auto-rotate	Tap the icon to enable/disable the Auto-Rotate screen function.
10	Pin Pad	Tap the icon to enable the Pin Pad function.  <p>NOTE:</p> <ul style="list-style-type: none"> Optional function; availability depends on the tablet PC specifications.
11	Setup	Tap the icon to configure the scanner button or the P1 and P2 function buttons. 

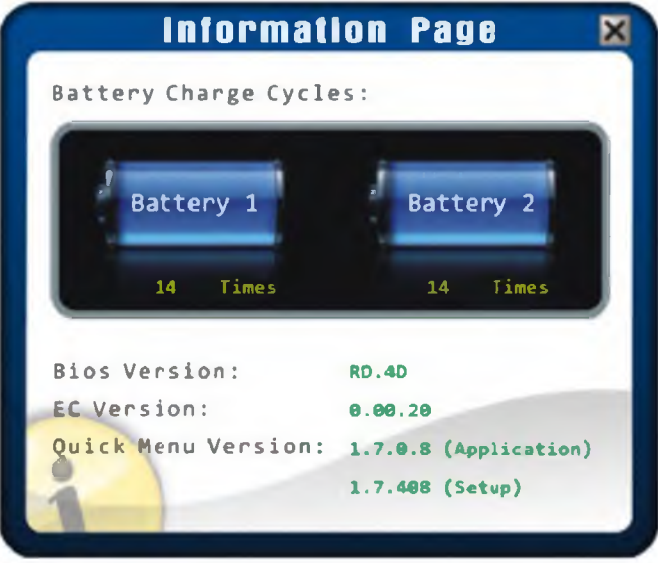
No.	Item	Description
12	Information	<p>Tap the icon to view the battery charge cycle, Bios version, EC version, and Quick Menu version.</p>  <p>The screenshot shows a window titled "Information Page" with a close button in the top right corner. It displays the following information:</p> <ul style="list-style-type: none">Battery Charge Cycles: A graphic shows two battery icons, "Battery 1" and "Battery 2", each with "14 Times" written below it.Bios Version: RD.4DEC Version: 0.00.20Quick Menu Version: 1.7.0.8 (Application) and 1.7.408 (Setup)

**NOTE**

- A gray icon (i.e. ) indicates the current function is disabled

Using the BIOS Setup Utility

Your tablet PC has a BIOS setup utility which allows you to configure important system settings, including settings for various optional functions of the tablet PC. This chapter explains how to use the BIOS setup utility.

BIOS Setup Menu

The BIOS Setup Utility allows you to configure your tablet PC basic settings. When you turn your tablet PC on, the system reads this information to initialize the hardware so that it can operate correctly. Use the BIOS setup utility to change your tablet PC start-up configuration. For example, you can change the security and power management routines of your system.

Starting the BIOS Setup Utility

You can only enter the BIOS setup utility as the tablet PC is booting, that is between the time you turn on the tablet PC and before the Windows interface appears.

1. Connect a USB keyboard to one of the USB ports of your tablet PC.



2. If your tablet PC is already on, restart your tablet PC.
3. When the start up logo appears, press the <Enter> key on the USB keyboard to enter the setup utility.

Navigating and Entering Information in BIOS

Use the following keys to move between fields and to enter information:

External Keyboard	Description
← →	Selects screen.
↓ ↑	Moves up/down to select items.
Enter	Confirms the selection and enters the selected menu screen.
+ / -	Changes an option for the selected items.
F1	Displays the Help screen.
F2	Invokes the previous values.
F3	Loads optimized default values.
F4	Saves the changes and exits Setup.
Esc	Exits any section. If you wish to exit the BIOS utility without saving changes or go to the main menu, then press this key.

Users are allowed to enter new values to replace the default settings in certain fields and some fields are specified by system default parameters and cannot be modified by users. Reverse the attribute of the main options and press the <**Enter**> or ↓ button to enter a submenu. Press the <**Esc**> button to return to the previous configuration page.

Optional Devices

The functionality of your Tablet PC can be expanded with the use of devices, such as the Magnetic Stripe Reader (MSR), Pin Pad, and others. These devices are optional items and may be purchased separately.

Magnetic Stripe Reader (MSR)

The integrated Magnetic Stripe Reader (MSR) can be installed on your Tablet PC as shown below.



MSR Specification

MSR Specification	
Supported Protocol	ANSI/ISO 7810, ISO 7811-1/6, 7813, JIS X6301, X6302, AAMVA
Frequency	Two-frequency coherent phase (F2F) recording methods
ISO	ISO Track1 - IATA , Track2 - ABA and Track3 - THRIFT decoding methods
Reading and Encryption	Bi-directional card reading Supplies 54 byte value Encrypts all track data and the value
Speed	Card speed through the unit may vary from 3 ips to 100 ips (7 cm/s to 250 cm/s)

Specifications

Features		Specifications
Processor	Type & Speed	Intel Atom N2600 1.6GHz 512KB x2 L2 cache
Chipset		NM10
System Memory	Type	DDRIII 800 One 204-pin DDRIII SODIMM sockets for 2GB
	Maximum Memory	2GB
Display	Display	Standard : <ul style="list-style-type: none"> 10.1" WXGA (1280x800) TFT LCD with resistive multi-touch panel Optional Sunlight readable: <ul style="list-style-type: none"> 10.1" WXGA (1280x800) TFT LCD with sunlight readable resistive multi-touch panel
	Screen Auto-rotation	Support screen auto-rotation
	Light Sensor	Built-in ambient light sensor-
	Digitizer	Optional Digitizer with active stylus pen with USB interface battery-charger Auto switch between digitizer and touch input
Storage	SSD	mSATA SSD 32/64/128 GB
I/O Devices	Expansion Slot	<ul style="list-style-type: none"> Smart card reader SD card slot (SDHC)
	Camera	<ul style="list-style-type: none"> Front facing 1.3M pixel camera Optional rear facing 5M pixel auto-focus camera
	Barcode scanner	Optional Barcode scanner, support 1D/2D barcode
	RFID	Optional NFC RFID reader support ISO 15693 / 14443A/B / NFC ISO 18092
	Communications	Internal 10/100/1000M bit Ethernet LAN Intel Centrino Wireless N 135 (WLAN 1x1 b/g/n and Bluetooth 4.0 EDR) Optional Mini PCI-e connector for WWAN/GPS (Gobi 3000 or LTE module)

Specifications

Features		Specifications
I/O Devices	I/O Ports	<ul style="list-style-type: none"> ▪ Bottom Side I/O: RS-232x1, RJ 45x1, USB 2.0x2, DC-inx1 ▪ Rear Side I/O: Docking connector x1
Audio		HD Audio One speaker Analog Mic. Array (With 2 Microphones)
Power	AC/DC Adapter	Input:100V-240V, 50Hz-60Hz, Output:19V, 3.42A; 65W Compliant with Energy Star 5.2
	Battery Module	Two Li-Ion battery packs (11.1V, 2600mAh, 28.86 W)
	Battery Life	7~8 hrs
Environment	Operating Temperature	-20°C ~ 45°C
	Storage Temperature	-33°C ~71°C
	Operating Humidity	5% ~ 95%
	Drop	26 drops with 4 feet high to 2" plywood over concrete, unit on with SSD
	Dust Proof/Water Sealing	IP-4X / IP-X3
	Vibration	MIL-STD 810G 514.6 Procedure I category 24 Figure 514.6E-1, unit on with SSD
Operating System		Windows 7 Professional x86 Windows Embedded Standard 7 (by customer request)
Security		Computrace Enable BIOS Administrator password Boot password TPM 1.2 (PCBA option) Kensington Lock slot
Dimensions		274 (W) x 202 (H) x 45.9 (D) mm / 10.8 (W) x 8.0 (H) x 1.8 (D) inch
Weight		Weight: 1.47 kg / 3.24 lbs

Specifications are subject to change without prior notice.

по вопросам продаж и поддержки обращайтесь:

Архангельск (8182)63-90-72 Астана +7(7172)727-132 Белгород (4722)40-23-64 Брянск (4832)59-03-52
Владивосток (423)249-28-31 Волгоград (844)278-03-48 Вологда (8172)26-41-59 Воронеж (473)204-51-73
Екатеринбург (343)384-55-89 Иваново (4932)77-34-06 Ижевск (3412)26-03-58 Казань (843)206-01-48
Калининград (4012)72-03-81 Калуга (4842)92-23-67 Кемерово (3842)65-04-62 Киров (8332)68-02-04
Краснодар (861)203-40-90 Красноярск (391)204-63-61 Курск (4712)77-13-04 Липецк (4742)52-20-81
Магнитогорск (3519)55-03-13 Москва (495)268-04-70 Мурманск (8152)59-64-93 Набережные Челны (8552)20-53-41
Нижний Новгород (831)429-08-12 Новокузнецк (3843)20-46-81 Новосибирск (383)227-86-73 Орел (4862)44-53-42
Оренбург (3532)37-68-04 Пенза (8412)22-31-16 Пермь (342)205-81-47 Ростов-на-Дону (863)308-18-15
Рязань (4912)46-61-64 Самара (846)206-03-16 Санкт-Петербург (812)309-46-40 Саратов (845)249-38-78
Смоленск (4812)29-41-54 Сочи (862)225-72-31 Ставрополь (8652)20-65-13 Тверь (4822)63-31-35
Томск (3822)98-41-53 Тула (4872)74-02-29 Тюмень (3452)66-21-18 Ульяновск (8422)24-23-59
Уфа (347)229-48-12 Челябинск (351)202-03-61 Череповец (8202)49-02-64 Ярославль (4852)69-52-93

единый адрес: dbk@nt-rt.ru

durabook.nt-rt.ru